

This Adobe Acrobat PDF file has been downloaded from the Quality Monitoring Instruments Ltd. website at www.oilmist.com

This is a web edition and as such is not optimised for print.

This information is subject to change. Please contact us for more information. Our contact details can be found below.

Thank You.

QMI Ltd.



OIL MIST DETECTION AS AN AID TO MONITORING AN ENGINE'S CONDITION

PUBLICATION 524

AUTHOR
Brian J. Smith
AIMarEST, MIDGTE



Akroyd Stuart Award 2001

Introduction

As diesel engines become progressively more efficient by burning fuel more effectively, the only remaining significant potential for operational cost saving to be exploited is to introduce features to ensure that unnecessary maintenance is reduced. Owners and operators of diesel power plants are increasingly seeking ways to replace preventive maintenance schedules based on operational hours by on-condition maintenance programmes that confine maintenance to the actual needs of the engine. Such a philosophy requires appropriate use of accurate health and condition monitoring equipment that not only tracks critical performance parameters, but also provides suitable protection against more serious damage being inflicted due to incipient seizures. Oil Mist Detectors are an important component part of this changing philosophy.

The History Of Oil Mist Detection

The earliest recorded experience of oil mist fires and crankcase explosions go back to the very beginning of diesel engine development. Rudolf Diesel mentions them in his early writings.

Matters were finally brought to a head regarding explosions and fires when a major disaster aboard the MV "REINA DEL PACIFICO" in 1947 took place just as she was leaving Belfast dockyards after a complete refit. This incident involving the death of 28 people has been well documented. A British Government Inquiry was set up to find ways of making sure no more tragedies of this magnitude occurred again.

The outcome of the research into the above accident was the development of standards aimed at improvement of the design, application, and associated performance, of pressure relief doors mounted on the crankcase. This was a step forward in safety. The solution however only went half way to solving the problem because the pressure relief doors, were essentially confined to controlling the effect of an internal explosion, to ensure minimum external damage to personnel and equipment. Essentially the design was such as to unload the pressure through a relief valve on the door, the evacuation taking place through a gauze packing to quench the flame. A further feature of the design was the rapidly closing valve to prevent the ingress of air that could promote a secondary explosion.

This initial work therefore centred on the control of the effect rather than preventing the cause. As both engine ratings and the physical size of engines increased during the 1960's, it was evident that addition steps should be taken to reduce the risk or internal explosions, so inevitably interest was directed towards detection of the conditions existing immediately prior to an explosion.

It was realised that a crankcase explosion resulted from the self ignition of an oil vapour from a hot-spot, the vapour itself being caused by the progressive and excessive increase in temperature of an internal surface due to high friction loads, due to incipient seizure between surfaces.

Effort was therefore applied to the development of monitoring equipment that would detect the onset of a problem which would initially manifest itself by the generation of localised high density oil mist.

The first crankcase oil mist detector was marketed in the early 1960's. The design principle used has been retained by many suppliers of this equipment to this day, and involves the extraction of the oil mist from selected points within the crankcase which is then transferred in sequence via discrete pipes to a central detector usually mounted on the engine, with a facility for remote reading at a centralised panel.

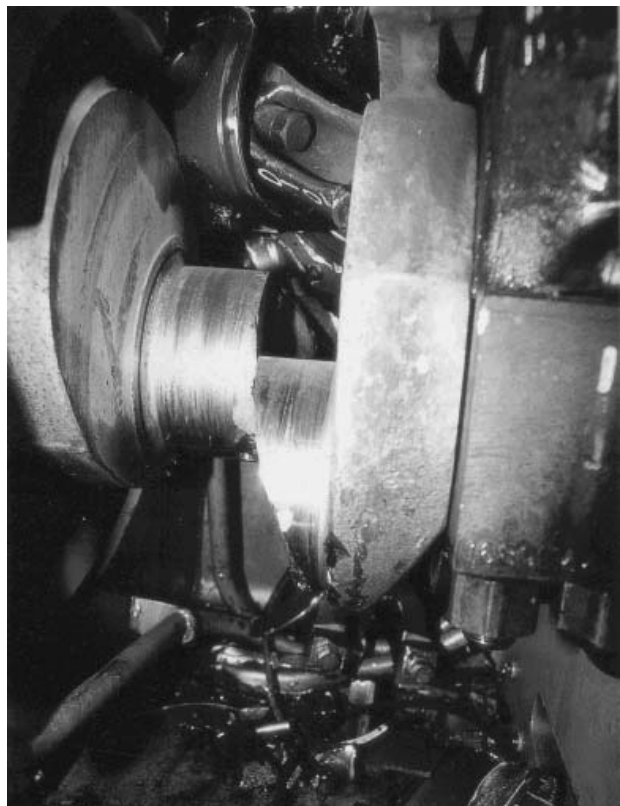

Figure 1: Stop This!

Oil Mist Detection

Advances in technology have been such that health monitoring has now become increasingly important with regard to diesel engine maintenance and safety. Oil mist can give some of the first signs of impending problems for all the moving parts of the engine. It is acknowledged that temperature and pressure indication can also provide appropriate early warning of potential problems with certain components, particularly those components that can be fitted with temperature probes.

Today's diesel engines are varied in design and are a mixture of slow, medium, and high-speed, large and small cylinder bore. Diesel engineers have been particularly concerned with hazards associated with using large bore engines due to the possibility of explosive type atmospheres in the diesel engine crankcases. As a result Classification Societies require that crankcase oil mist detection equipment or temperature bearing sensors be fitted to large bore diesel engines in order to reduce the risk associated with these engines.

Over the last 15 years QMI has been fitting oil mist detection equipment to engines of various bore sizes, including slow, medium, and high-speed engines.

Classification Of Oil Mist

Class 1

An inherent layer of oil mist can be found in all engine spaces. It is caused by vapourisation of the lubricating oil as a direct result of localised normal, but nevertheless high temperatures, and the work sustained by the oil in the process of lubricating and cooling bearings, piston and piston rings and gear trains. This mist condenses on the cooler crankcase walls and is reasonably constant although it will inevitably increase slightly with power output. This type of oil mist does not typically create a problem. In fact, for the correct operation of the QMI Multiplex™ Oil Mist Detection System, its presence is essential.

Class 2

This type of oil mist is generated from hot spots that occur as a result of high-localised friction loads or loss of lubrication of the bearings. Oil mist will be generated above the inherent layer of oil mist created by oil splash that is already present falling on to the hot spots. Oil droplets hitting the hot spots

boil and create a larger quantity of oil mist. Monitoring the build up of this oil mist is an excellent way to detect wear of the bearings and pistons at a very early stage.

Class 3

This type of oil mist is similar to Class 2 except instead of the oil boiling it aerosols on being exposed directly to the products of combustion escaping past the piston rings.

Class 4

A large number of marine fires in machine rooms begin with oil mist in the surrounding area. Oil mist escaping from injectors, leaking fuel, lubricating or hydraulic oil pipes can gather in engine and machine room spaces. This type of oil mist can be detected by oil mist detection equipment such as that developed by QMI. It should be possible to prevent most fires and minimise damage if an early warning is given.

What We Should Know about Oil Mist

There are two types of oil mist but only one that should concern us and they are known as blue and white smoke.

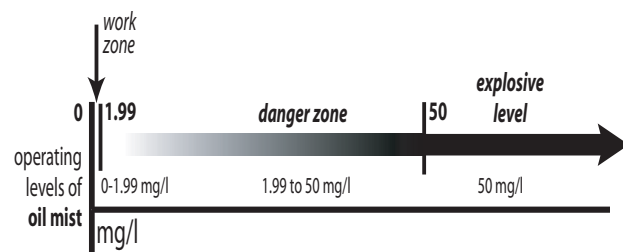

Operating Levels of Oil Mist

Figure 2: Operating Levels of Oil Mist

Blue Smoke

Blue smoke is identified by its colour and can only be caused when the oil temperature rises to 800°C or higher. This mist has a particle size of about one-micron. It is not present in the machinery that is monitored. It is worth noting the importance of being able to identify one type of smoke from the other. Blue smoke can be seen and is extremely dangerous. It normally only occurs during a major fire.

White Smoke

It is important to detect this type of oil mist as it can be generated at quite low temperatures and has a particle size of between 3 and 10 microns. It is described in Classes 1, 2, 3 and 4 above. If concentrations greater than 50mg oil /l air of oil mist, which is the lower explosive level (LEL), has accumulated, it will take a temperature as low as approximately 200°C to ignite the oil mist. This can result in a crank space explosion and considerable damage to the engine. Most engines will have seized before this amount of oil mist has been generated. Early detection can significantly reduce corrective maintenance costs.

The main user of oil mist detection systems is the Merchant Fleet as it is mandatory to have either bearing temperature sensors or an oil mist detection system on engines over a certain size depending on the Classification Society requirements.

The problem with temperature sensors is they can only look at the bottom end of the engine, whereas oil mist detectors can monitor the top and bottom of the engine. The Merchant Fleet normally fits oil mist detectors or, in some instances, both oil mist detection and bearing temperature sensors.

Crankcase Explosions

When an explosion occurs within the confines of a crankcase the crankcase door is vulnerable to damage. Where a set of correctly designed pressure relief valves are fitted, the pressure is relieved and it is unlikely that external structural damage will be experienced. In both instances however injuries to operators can occur if they are close by when the incident occurs. There is also the added risk of a secondary explosion caused by the ingress of fresh air into the confines of the crankcase.

An oil mist detection system can stop damage to the engine and, most importantly injury to engine room personnel by allowing early detection of engine wear and bearing damage which could lead to an explosive environment within the engine.

Oil mist detection equipment, when used in the correct way, can therefore be used as a health monitoring facility to assist in the determination of the condition of the machinery, so that the necessary servicing can be highlighted at an early stage of a condition change taking place.

As already stated there is an inherent oil mist level within the engine that acts as the base line. (See Class 1.)

If the oil mist readings are manually or electronically logged the increased levels of oil mist will become apparent as wear takes place. Remember wear starts from small beginnings and with awareness of this preventative action can be taken.

The QMI Oil Mist Detection System

QMI have for the past 18 years been developing the Multiplex™ System to detect oil mist in diesel engine crankcases and in sensitive operating environments. Our efforts were directed to overcome a number of problems that were well known to users.

What is most needed in an Oil Mist Detector?

- a A fast and accurate response - this can only be achieved with a detector mounted on each crankcase to detect the level of oil mist at the source of the problem. This eliminates unnecessary pipe-work where oil mist can condense and take time to travel to the monitor.
- b No false alarms - to make this possible absorption must be replaced with light scatter so that there can be no mistake between oil mist and dirty lenses. Detailed explanation of these terms is given later.
- c Direct reading of a known value such as mg/l and having a linear output.
- d Must have a known maximum oil mist alarm level, not one that can be changed at will.
- e Must work on direct readings taken in each compartment of the crankcase.
- f Must not use compressed air for calibration, as this tends to contaminate the lenses so that it is not possible to distinguish between a false alarm or an engine problem. Also contaminated air gums up the valves within this type of oil mist detector.
- g It must be possible to accurately read the oil mist levels in each crankcase simultaneously without scanning.

- h It should be possible to log oil mist readings either manually or electronically.
- I No siphons or valve that can block and stop oil mist reaching the monitor.
- j Last, and most important, an oil mist monitoring system that has the monitor mounted in the control room and not on the engine.

QMI uniquely uses the light scatter method to measure oil mist concentration see Fig. 2. This is also known as Nephelometry

The measurement of oil mist using the Nephelometry light scatter method greatly differs from conventional Obscuration light absorption systems used by other suppliers.

Light scatter has the advantage of being linear in output and has a true zero. This means it is possible to quantify the oil mist as a measurement in mg/l.

How Does Light Scatter Work?

A good analogy of how light scatter works is the flecks of dust seen in a beam of sunlight streaming through a window. In reality these are not dust particles but light scatter reflecting from the sun off the dust. The QMI system transposes the sun with an LED transmitter; the dust then becomes oil mist particles. Incorporated is a receiver at approximately 90 degrees to the transmitter. This receives the light scatter. Directly opposite the LED transmitter is another receiver that measures the amount of contamination building up on the LED

Schematic diagram showing principle of nephelometry

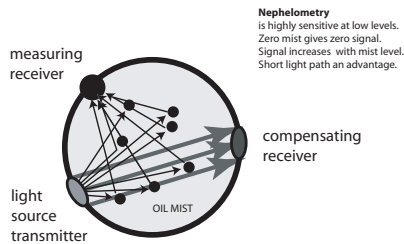

Nephelometry is highly sensitive at low levels. Zero mist gives zero signal. Signal increases with mist level. Short light path an advantage.

Typical graph produced by nephelometer

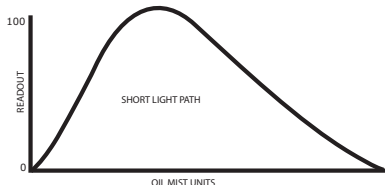
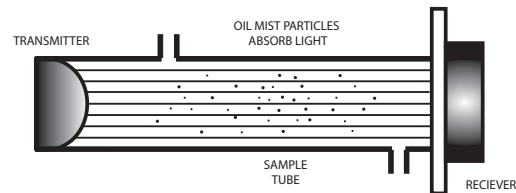

Figure 3: The Principle of Nephelometry

Optos to compensate the oil mist readings. This allows for up to 50% of contamination on the lenses. The main advantage with the system is that the detectors can be calibrated and it is also possible to obtain a true zero. If there is no oil mist no light can be scattered to the receiver. If, however oil mist is present, then light will be received from the scatter. Thus it follows the more oil mist there is the more light will be received. By use of a complex program, it is possible to obtain readings that are linear in mg/l and this makes it easier to read as it relates to the known LEL of oil mist. By using light scatter small detectors can be placed along side each crank compartment thereby obtaining readings simultaneously within approximately 0.5 seconds of the mist being produced.

Schematic diagram showing principle of absorptometry



Typical graph produced by absorptometer

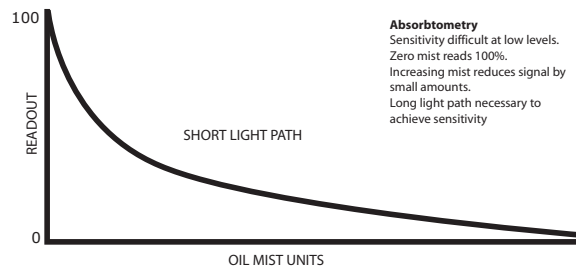

Figure 4: The Principle of Absorptometry

How Does Absorption Work?

Obscuration used by many oil mist detection equipment suppliers works in the opposite direction to light scatter in that if there is no oil mist there is a 100% light transfer. Obscuration works on the principle of having a sensing chamber with a transmitting LED at one end and an LED receiver at the other. Therefore when oil mist is passed into the sensing chamber the light diminishes. The more oil mist contained in the space between the transmitter and the receiver, the less light is received by the LED receiver. At the same time contaminated air can be drawn onto the LEDs from the comparator source.

This can lead to a false alarm as the difference between a contaminated LED and a high oil mist concentration cannot be recognised. (This is a very real problem and should be emphasised.)

Obscuration does not allow a true zero as the instrument needs to be set up on a running engine, therefore the oil mist level seen by the monitor is not known.

Absorption is not linear. This is why this type of oil mist monitor cannot relate quantified measurements such as mg/l. It has to rely on looking for deviations to operate the alarm system. Each crank compartment needs to be scanned at least twice to set a deviation and this is then compared with a compressed clean air comparator. Normally this air supply is contaminated as there is usually no clean air supply available in the engine room. The contaminated air is one factor in creating dirty lenses.

The two major problems with an obscuration system are they are prone to false alarm and are very slow in detecting rising oil mist.

The Monitor

The QMI monitor is normally placed in the control room or on the bridge well away from the danger zone i.e. the engine. Therefore should conditions become dangerous no personnel will be injured.

Nowadays most engine rooms are unmanned therefore all information about the engine should be immediately transmitted to the control room staff.

Other types of oil mist detectors allow the user to raise the maximum alarm setting indefinitely. QMI has a maximum pre-set program and can only be changed for high readings by changing the EPROM and this is not freely available.

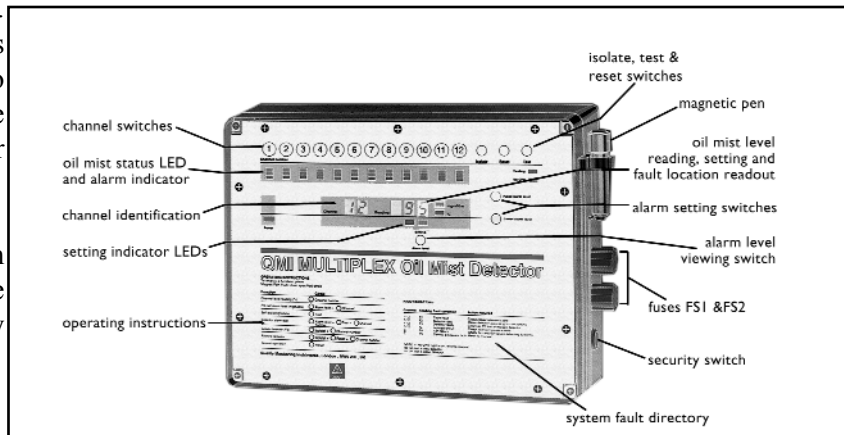

Figure 6: The QMI Monitor

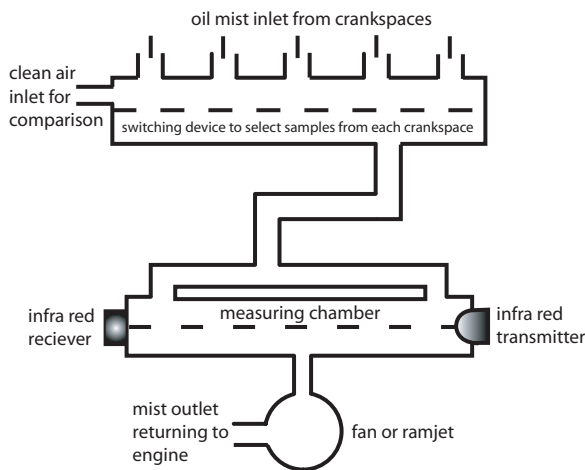

Figure 5: Photoelectric Tube Unit

Description Of The QMI Multiplex™ System

The equipment consists of a small number of components such as The Monitor, Detectors, Fan and Multi-way Junction Box.

The monitor processes all the information transferred from the detectors that are mounted on the engine. It gives continuous information to operatives in three ways:

- A Traffic Lights - RED, AMBER, and GREEN
These indicate the state of oil mist and areas of alarm within the engine or the monitoring system. There is a set of lights for each detector.
GREEN - indicates up to 80% of alarm setting
AMBER - indicates from 80 - 99% of alarm setting.
RED - indicates 100% of alarm setting.
ALL THREE FLASHING - indicates an instrument fault.

- B Digits The digits are used to set the alarm levels in mg/l during the setting up procedure, and as a percent-

age of the alarm setting in the running mode. It also indicates system faults should they occur by means of a self-diagnostic program.

C

Alarm relays and engine slow/shut down There are 4 relays built into the unit. The first is used as an early warning alarm when 80% of the alarm setting is reached. The second and third are activated when the oil mist gets to its full alarm setting i.e. 100%. The second relay operates the main alarm and third relay the engine slow or shutdown system. A fourth relay comes into use when there is a fault in the operating system, which is independent of the engine operation.

As the instrument is completely micro processor driven a number of other useful functions can be incorporated such as using the monitor on more than one engine each with its own slow/shutdown function. Oil mist readings from each detector can be data-logged. The program also allows it to ignore transient blow-by and indicates the area of the engine where the trouble has occurred. In the event of a failure it locks onto the channel that first goes into alarm.

The Detectors

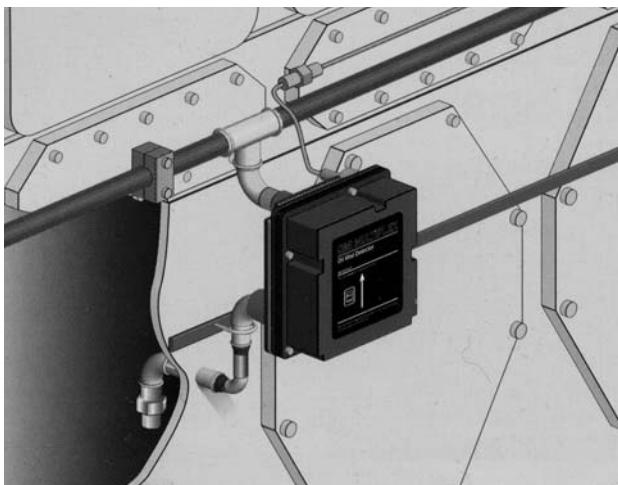

Figure 7: The Detectors

These are mounted at each crank compartment, gear or chain-case housing and thrust bearing, housing if this has its own space. The detector incorporates LED optos and a PCB. A microprocessor, that is built into the unit, sends five sets of information to the monitor each 0.5 seconds via a cable connection

where it proceeds to give all the relevant reading and alarms to the operatives. There is no interaction between detectors as they are independent of each other

The Multi-Way Junction Box

This is a Junction between the detectors and the monitor. Each detector is wired together with the Fan Failure sensor to the Junction Box that is located near to or on the engine. A multi-core cable is run from this unit to the monitor.

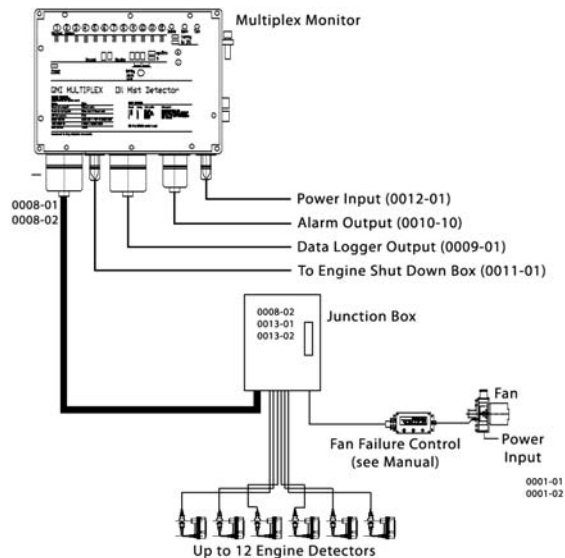

Figure 8: The Multi-Way Junction Box

Fan with Magnetic Sensor

This is a small AC 110/240V unit that is used to draw the oil mist through all of the detectors via a single manifold. Mounted on this fan is an electromagnetic sensor to prove that the impeller is rotating.

Pipework Layout Of The QMI Multiplex™ Monitoring System

as shown in Figure 9.

Mist is continuously being extracted by means of a fan attached to the end of a manifold, to pull oil mist into the detector where it is measured. From the fan, the oil mist is generally ducted to the engine breather or returned to the crankcase.

To get the best overall advantage of the system it is necessary to either manually or electronically logs the detector readings. These readings will then indicate at a very early stage when a bearing or piston failure starts.

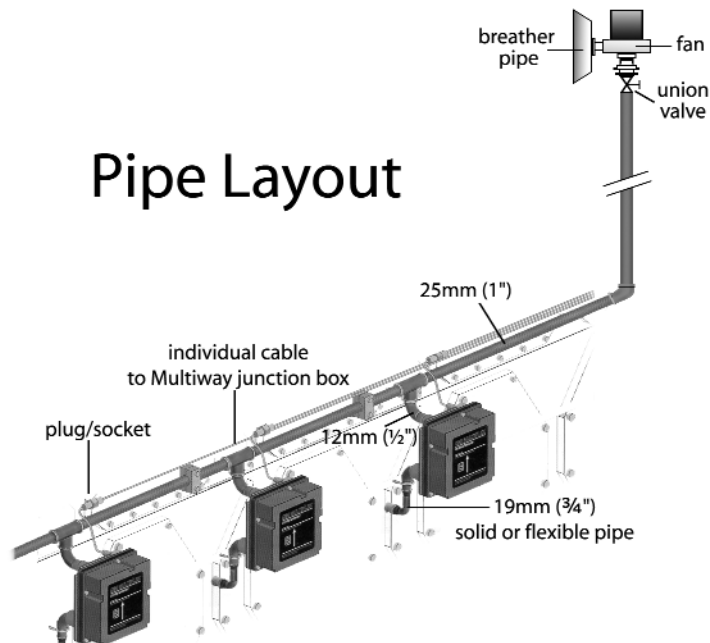

Figure 9: Pipework Layout of QMI Multiplex™

Remedial work can then be carried out long before a major incident occurs. QMI have overcome most false alarm problems and have a system that responds very quickly to oil mist level changes.

The Advantages Of The QMI Multiplex™ System:

- I. True measurement of concentration of oil mist is achieved.
- II. Oil mist drop-out is minimised
- III. Direct measurement at the crankcase by multiple measuring cells gives high redundancy to the system
- IV. Faster response (0.5 seconds) means saving the engine from damage caused by bearing failures.
- V. Continuous parallel sampling directly eliminates the use of valves, which are high maintenance
- VI. Continuous true readings give trends for analysis and accurate fault prediction.

The following are figures giving an indication of the type of results that are achieved by manual logging or data-logging oil mist readings.

Figure 10 shows how, on a B&W S 80MC Engine on the M/V "BRITISH PIONEER". Moving the oil mist detector to a higher location made it possible to obtain a clear and consistent picture of what is taking place in the crank compartment. The first three sets of readings were taken in the original position as indicated by B&W. Later, the detectors were placed higher in the crank compartment. (See accompanying notes to be read in conjunction with the graph.)

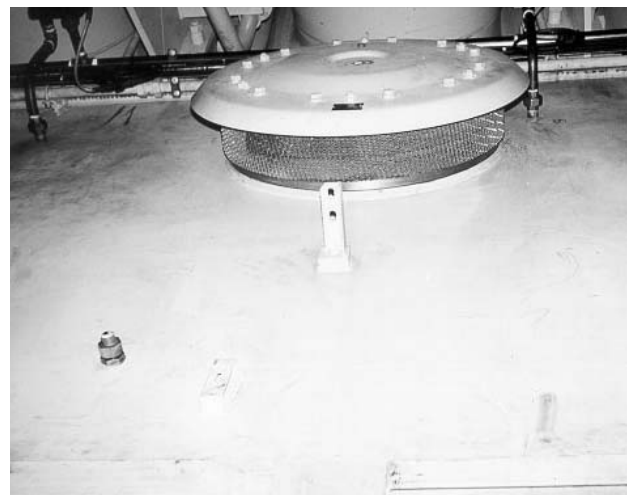

**Figure 10: Oil Mist Detector
M/V British Pioneer**

Explanatory Notes - Tables 1 and 2

Oil mist levels found in crank spaces of B&W Engines - Type S80MC

1. The level of alarm was originally set at 0.49mg/l until the 20th May '00, when it was increased to 0.69mg/l. to ensure the monitor did not operate in the 50% and above range, bearing in mind the LEL is approx. 50mg/l.
2. The readings of the monitor go up in 1% divisions to 30% of the alarm setting. Above this they go up in 5% divisions. This means a 35% reading could be between 31-39%, depending upon if the oil mist level is rising or falling. You will appreciate this is a very small amount of oil mist in terms of mg/l.
3. Note, the lower the RPM the higher the oil mist reading. This is as a result of the wash

out effect of the oil spray not being so great and there being less turbulence which allows the oil mist to increase.

4. Detector readings 1 to 3 were taken when the detectors were installed, as per B&W positioning instructions. Readings 4 and 7 were taken when the detectors were repositioned at the top of the crank compartment, as specified by QMI. Readings then became higher and more stable.
5. Detector No. 8 was mounted to monitor the chain-case and was set at 0.29mg/l. Readings were low due to the oil mist being washed out as a result of very large amounts of oil splash. By setting the alarm lower than the detectors 1-7, should any problem occur it would immediately slow or shut the engine down.

To show the different type of figures that various engines produce, the readings of a Caterpillar 3616 on the M/V "STENA SEA LYNX II" are shown in Table 3.

B&W S80 MC ENGINE

No	Date	Ship	RPM	Setting mg/l	M/V British Pioneer % of Alarm Setting of Detectors								Setting 0.29 mg/l	REMARKS No. 8 Chain Case
					1	2	3	4	5	6	7	8		
1	6/4	27686	76	.49	9	6	10	10	5	9	4	8	Before relocating detector	
2	"	"	"	"	17	15	17	12	8	15	7	15	"	
3	"	"	"	"	20	16	22	22	10	20	8	10	"	
4	2/5	?	66	"	40	35	35	35	24	30	20	7	10 min after start-up of retrofit	
5	"	?	"	"	40	40	40	40	35	40	30	20	60 min " " "	
6	3/5	17950	63.7	"	0	0	45	40	40	40	29	14	Baffles on No. 1 block head	
7	"	"	"	"	0	30	45	45	45	40	29	17	Baffles on No. 1 block head	
8	"	"	"	"	0	35	45	45	45	40	29	10	Baffles on No. 1 block head	
9	4/5	18704	67.8	"	0	29	45	45	45	45	35	14	Baffles on No. 1 block head	
10	"	"	"	"	0	0/30	45	40	45	40	27	6	BaffleNo 2 becoming blocked	
11	"	"	"	"	0	0/30	40	35	45	45	24	8	BaffleNo.2 becoming blocked	
12	20/5	25500	73	.69	30	40	35	35	35	28	29	6	Baffles unblocked No. 1&2	
13	21/5	"	"	"	28	35	35	35	35	29	29	9		
14	22/5	"	"	"	30	40	35	40	35	28	35	20		
15	23/5	27300	74	"	29	35	35	35	35	29	35	18		
16	24/5	"	"	"	25	30	35	35	35	28	26	12		
17	30/5	19000	66	"	17	25	30	25	26	22	22	6		

Table 1:

The second set of figures were taken on the same type of engine on board the M/V "BRITISH PROGRESS". This shows the consistency that occurs. In other words, each engine type and make has its own characteristics. You will also note that the actual oil mist in a crosshead engine is normally very low, bearing in mind these are percentage figures of the mg/l setting and the readings vary depending upon speed and load. The reason for low oil mist in this type of engine is because there is a large area of metal on which the oil mist condenses. If the detectors are mounted too low in the crank compartment there will be a washout of oil mist by the oil droplets.

No	Date	Ship	RPM	Setting mg/l	M/V British Progress % of Alarm Setting of Detectors								Setting 0.29 mg/l	REMARKS No. 8 Chain Case
----	------	------	-----	-----------------	--	--	--	--	--	--	--	--	-------------------------	-----------------------------

					1	2	3	4	5	6	7	8	
8	24/10	-	-	.49	45	24	30	55	50	29	35	40	

Table 2:

M.V. STENA SEA LYNX II % READINGS OF 1.9MG/L								
CRANKSPACE								
Date	1	2	3	4	5	6	7	8
11.09.92	55	65	70	75	70	70	50	75
	55	65	70	75	70	70	50	75
	55	65	70	75	75	70	50	75
	55	60	65	70	70	75	55	75
12.09.95	50	65	65	70	65	65	23	75
	50	65	70	70	70	65	21	80
	50	60	65	70	65	60	14	75
13.09.95	60	65	65	75	70	70	65	70
	45	65	65	75	70	80	45	80
	40	65	65	70	70	80	16	80
	40	65	70	75	70	80	40	80
	45	65	65	70	70	80	26	75
	50	65	70	75	70	80	50	75

Table 3:

The last set of figures were taken from Paxman Valenta engines, type 12PR200L, which were on the test beds at the Railway Works at Crewe. Every engine, irrespective of type and make, sent out by Crewe has a set of these figures that have been logged to prove the engine is in a perfect state before leaving the Works.

Engine:				Paxman Valenta 12 PR200L		Serial No. S340			
				Number of Cylinders					
				1	2	3	4	5	6
750	RPM	220	KW	55	50	60	18	60	26
750	RPM	250	KW	55	50	60	28	55	20
1000	RPM	571	KW	50	45	50	22	45	24
1150	RPM	641	KW	45	45	55	21	45	35
1150	RPM	843	KW	50	45	55	30	50	45
1350	RPM	1201	KW	45	50	55	29	55	45
1500	RPM	1350	KW	50	55	55	30	60	55
1500	RPM	1531	KW	60	60	60	35	65	55
1500	RPM	1609	KW	60	60	55	35	65	55

Engine:				Paxman Valenta 12 PR200L		Serial No. P308			
				Number of Cylinders					
				1	2	3	4	5	6
750	RPM	220	KW	55	55	55	35	60	45
750	RPM	250	KW	60	60	60	40	60	50
1000	RPM	571	KW	50	45	45	50	22	40
1150	RPM	641	KW	45	45	40	14	45	40
1150	RPM	843	KW	50	45	40	17	45	40
1350	RPM	1201	KW	50	45	45	12	45	40
1500	RPM	1350	KW	45	45	40	8	45	40
1500	RPM	1531	KW	45	45	50	14	50	45
1500	RPM	1609	KW	45	45	45	14	50	45

Engine:				Paxman Valenta 12 PR200L		Serial No. S438			
				Number of Cylinders					
				1	2	3	4	5	6
750	RPM	220	KW	60	35	60	60	70	35
750	RPM	250	KW	50	35	65	65	65	40
1000	RPM	571	KW	45	25	45	55	60	35
1150	RPM	641	KW	50	22	45	50	55	45
1150	RPM	843	KW	45	35	45	50	60	55
1350	RPM	1201	KW	45	22	50	45	60	55
1500	RPM	1350	KW	45	35	45	50	50	50

The above readings show a good example of engines operating with no problems. The oil mist level will only rise as a condition change takes place due to wear.

Tug BAUS. Engine

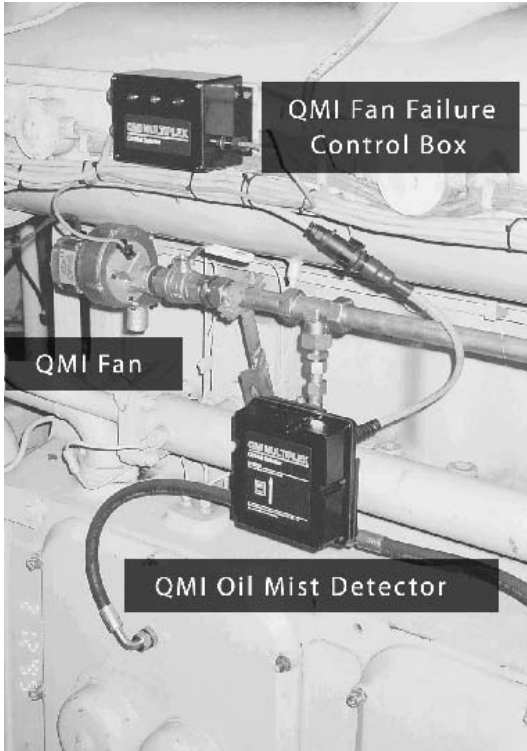

Tug BAUS. Engine M.e 8M551AK, 2360 kW, built 1970
 Information from BAUS' Chief Engineer.
 Normal readings on Multiplex; 12% of 1,99 mg/l
 When towing in ice; readings 30% of 1,99 mg/l



A SELECTION OF LAND-BASED INSTALLATIONS SHOWING THEIR DIVERSITY

LAND FILL SITES & MINES: -

CUSTOMER LOCATION	SITE	NUMBER OF ENGINES
Shanks & McEwan	Brogborough	2
Dales	Rixton Hall	1
Maghara	Egypt	4

UNDERGROUND GAS STORAGE:-

CUSTOMER LOCATION	SITE	NUMBER OF ENGINES
Direct Gas	Belgium	5

POWER STATIONS:-

CUSTOMER LOCATION	SITE	NUMBER OF ENGINES
Metaldom	Dominica	1
Manx Electricity	Pulrose	5
Scottish & Southern Power	Lerwick	6
Solomon Isle Power	Solomon Islands	1
Club Med.	Djibouti	2
Thames Water	Crossness	1
Societe Des Ciments Libanais	Lebanon	7

TEST HOUSES: -
 Engine Builder
 Research Houses
 Railways
 Navy

Conclusion

There are many advantages to be gained from applying modern Oil Mist Detection Systems to a power plant. Essential information is transferred to remote control stations away from the potential danger zone thereby enhancing safe working conditions for engine room staff. New detection techniques, including those that have adopted light scatter principles, have advanced this important segment of engine protection technology to not only provide greater speed of response to any increase in oil mist but also to virtually eliminate spurious alarms. Improvements in the accuracy and consistency of detection components has additionally provided a facility whereby small changes can be more readily detected, opening up the possibility that such systems could be used for direction condition monitoring of the plant.

The Author

Brian Smith started his own company in 1961 to provide a range of Swiss thermometers for sale to various industries including diesel engine manufacturers. In 1965 he added to this by manufacturing electrical thermometers and pollution control instruments. At the beginning of the eighties he formed a company called Quality Monitoring Instruments Limited to develop a unique method of detecting oil mist. The result is a system now recognised world-wide as being the leader in that field. The current development programme includes a number of new models, with a special emphasis on detecting oil mist in the atmosphere, which can be used in intrinsically safe areas.

Acknowledgments

I would like to give my very special thanks to David Gillespie and Andrew Stroud for all their guidance and encouragement during the writing of the paper. My thanks are due to Rodney Smith of Testbank Ship Repair & Boiler Co. Ltd., for the practical suggestions he made. Thanks are also due to other members of the Institution for all their support and help.

Disclaimer

All the comments made in this paper are the authors own based on observations made over nearly twenty years in this field. To our knowledge they are correct even though some of the views may not always be agreed by everyone.

Questions AND ANSWERS

Bernard A. Cook
T.S.E. Rollo UK Ltd.

Question

Can this device be fitted to a negative pressure crankcase engine, e.g. the E.M.D. Detroit engines that operate with negative crankcase pressure and sensitive crankcase pressure sensors that can shut down the engine?

Answer

With our system it makes no difference as the oil mist sample is taken and returned to the engine which keeps the negative or positive pressure in balance. With regard to pressure sensors, there is no interaction between the two systems.

Andrew Stroud
Wärtsilä UK Limited

Question

Can you please confirm there is no need to carry out maintenance other than when the monitor indicates this is required. From your experience, are the ship's personnel able to carry out the required maintenance without affecting the performance or integrity of the device?

Answer

The only maintenance that is not monitored is blocked filters. If this occurs the oil mist readings will read 'very low or zero'. With regard to the actual maintenance work, this would normally be carried out by site personnel which incorporates cleaning the detectors and filters. The work can be carried out by unskilled labour and takes very little time. To avoid down-time, a spare detector should be used in this routine.

Question

Does the type of lubricating oil affect the calibration of the detectors and are there any adjustments that need to be made as the lube oil degrades or becomes contaminated by water or fuel oil?

Answer

Difference types of lubricating oils or fuels have no effect on the readings as we are looking at particles of oil mist.

Norman Rattenbury
Lloyds Register of Shipping

Question

Thank you for an interesting presentation that was both useful and thought provoking.

Could you please comment on the following:

- Given the very large volume of crankcases in modern 2-stroke cycle engines (W6000m3) are there any recommendations for the volume of crankcase per detector and their location?
- Are there any figures available to indicate typical mist growth rates for different engines following a fault being recognised by a mist alarm?

Answer

In theory on a two-stroke slow speed engine it may be preferable to have more than two detectors in one crankspace, but, as yet, no one has proved this, so we don't know if there would be any advantage. Having said this, to get an engine builder to have one detector let alone two would be beyond our wildest dreams. Here the problem of cost creeps in as engine builders are in a highly competitive market. Short sighted though it may be, oil mist detection is one place where they can save money. At the present time most manufacturers have no idea what level of oil mist is normal in their engine, irrespective of size. Our suggestion to the end-user is to specify the name of the oil mist detector they want as they will gain all the advantages in the long run.

Regarding the location of the detectors on 2-stroke engines, these should be placed as high as possible in the crankspace to avoid wash out of the mist from the oil splash as this is where it accumulates.

J. Cliffe
Consultant

Question

I would like to ask if there is an application for gas turbines? In the past leakage of oil mist from lube and hydraulic oil from tanks and pipes onto a hot turbine has been the cause of fires in confined installations.

Answer

We are now selling more oil mist detection systems for atmospheric applications as the biggest proportion of machine room fires are oil mist related. At the moment we are working with the HSE with regard to gas turbine rooms to see how accidents could be prevented. It is more than likely it will become mandatory in the future to install oil mist detection systems in these high-risk locations, based on work being carried out at this time by the HSE

John Blowes,
Diesel Consultant

Question

Crankcase explosion doors serve to release pressure in a controlled manner following an incident involving the combustion of crankcase mist. Even the oil level dipstick must be secure if an explosion is to be contained. Is it the case that entry into the crankcase doors and casing for mist detectors is a threat to the integrity of explosion containment?

Answer

We must have a sealed system for our unit to work efficiently as air leaks will dilute the oil mist going to the detectors. This means the safety of the engine will not be compromised.

Question

The speed of failure of thin shell crankshaft bearings can be alarmingly quick. 0.2s has been mooted for medium speed diesel engines. Is there a case for temperature sensing adjacent to each bearing, noting that telemetry is feasible to transmit large end bearing temperatures, with a view to this system

being a quicker method of detection?

Answer

'The final catastrophic failure of thin shell medium speed engine bearings can, in certain circumstances, be very quick, but the deterioration of the bearing prior to final failure will be slower. Protection systems must be capable of detecting the changes taking place prior to bearing conditions reaching the critical condition promoting the final failure. Experience shows that bearing temperature sensors, if correctly fitted and maintained, provide appropriate monitoring with sufficient accuracy to detect most changes in the monitored bearing condition that could ultimately lead to a final catastrophic failure. Oil mist detectors are capable of providing the same form of protection provided they are located correctly within the crankcase, with the added benefit that most surfaces within the crankcase with relative movement between components can in effect monitored by the same instrument. It is not uncommon for selected bearings to be protected by bearing temperature sensors in association with oil mist detectors, providing additional protection to the selected bearings whilst providing wider protection to all bearings within the monitored enclosure'.

John Harrison
Three Quays marine Services

Question

One manufacturer of high-speed engines (1100 - 1300RPM) in the power output range where oil mist detection or the equivalent is required by the Classification Societies does not install OMD's or temperature sensors having been exempted by the Classification Societies. The explanation given by the said manufacturer is that such RPM, response time of ODM's, is too slow to save a bearing/engine.

Answer

This argument is put forward with a view to saving money as it is felt it is very difficult to install oil mist detection. In reality, oil mist detection can be used to great effect - we know we have saved a fair number of engines.

Question

One current European medium-speed engine builder uses a single sample point in the crankcase vent pipe instead of a sample being taken from each cylinder or gear case.

Answer

This is not a good idea because oil mist takes a considerable amount of time to travel laterally through the engine and whilst doing so the oil mist is washed out by the oil splash. We have tried this type of system as have both our competitors, but we dismissed this as being unsafe due to the problems stated above, mind you it works out a cheaper option!

Question

Where high water content has occurred in the crankcase lube oil, normally caused by internal leakage, usually gradual or by accidental liner removal, etc., it has been found the water evaporates and steam activates the OMD alarm indicating faults which leads to distrust or disbelief in the instrument.

Answer

We have not experienced this problem as oil mist is not retained in the sensing head and as the infra red sensors are recessed in their housing, this also helps. If water does evaporate the amount of steam is far less than oil mist and with light scatter there is no fogging up of the sensor.